



Bhikshu Enterprise
Savour the flavor of design



SUITE 04



21 TABLE TOP



TOILETS 37



50 COUNTER BASINS



BASINS 54



68 URINAL & PAN



ACCESSORIES 71



73 TECHNICAL DRG





SUMO - 2068
Wall Hung Toilet
L-555, W-340, H-350mm



SUMO - 4010
Wall Hung Wash Basin
L-503, W-365, H-170mm



STACY - 2067
Wall Hung Toilet
L-537, W-350, H-345mm



SKA - 4054
Table Top Basin
L-400, W-300, H-115mm



STRAUSS - 2066
Wall Hung Toilet
L-550, W-345, H-350mm



STRAUSS - 4053
Wall Hung Wash Basin
L-383, W-455, H-153mm



SPRINT - 2062
Wall Hung Toilet
L-549, W-355, H-355mm



SPRINT - 1092
Table Top Basin
L-420, W-420, H-130mm



SNOW - 2059
Wall Hung Toilet
L-515, W-345, H-345mm



SNOW - 1069
Wall Hung Wash Basin
L-500, W-430, H-165mm



SANTO - 2057
Wall Hung Toilet
L-495, W-345, H-370mm



SANTO - 1068/1168
Wall Hung Wash Basin With Half Pedestal
L-560, W-430, H-440mm



SPARTAN - 2055

Wall Hung Toilet
L-505, W-380, H-395mm



SPARTAN - 1070

One Piece Wash Basin
L-450, W-470, H-340mm



SNEZZY - 2037/2137
Wall Mount Close Couple Suite
L-682, W-383, H-742mm



SNEZZY - 1016/1116
Wall Hung Wash Basin With Half Pedestal
L-550, W-445, H-575mm



SENIGMA - 2056
Wall Hung Toilet
L-545, W-355, H-350mm



SAMRAT - 1082
Table Top Basin
L-575, W-375, H-140mm



SENIGMA - 2044
Syphonic One Piece Toilet
L-660, W-355, H-720mm
'S' Trap - 220/300mm



SIRI - 4006/1117
Wash Basin With Full Pedestal
L-590, W-410, H-810mm



SANCITY - 2043
Wash Down One Piece Toilet
L-630, W-350, H-735mm
'S' Trap - 220/300mm - 'P' Trap - 180mm



SYDNEY - 1089
Table Top Basin
L-380, W-380, H-120mm



SONATA - 2042
Siphonic One Piece Toilet
L-680, W-400, H-660mm
'S' Trap - 100/220mm



SONATA - 1065/1130
Wash Basin With Full Pedestal
L-635, W-450, H-910mm



STENZA - 2036/2136
Concealed Close Couple Suite
L-730, W-355, H-830mm
'S' Trap - 220mm



STENZA - 1067/1167
Wash Basin With Full Pedestal
L-560, W-440, H-870mm



SANCITY - 2038/2132
Concealed Couple Suite Toilet
L-665, W-358, H-850mm
'S' Trap - 220mm



SANCITY - 1087
Table Top Basin
L-490, W-415, H-150mm



SPEED
2035/2 1 32
P Trap Toilet Couple Suite
L-710, W-460, H-810mm



SPEED
2035/2 1 35
P Trap Toilet Couple Suite
L-710, W-460, H-810mm



SANIYA
1063/1 1 63
Wash Basin With Full Pedestal
L-570, W-460, H-830mm



SPICE GOLD - 2028/2128
Wall Mount Close Couple Suite
L-690, W-390, H-755mm



SWISS - 1020/1120
Wall Hung Wash Basin With Half Pedestal
L-565, W-465, H-485mm



SARGAM - 1060

Table Top Basin
L-545, W-410, H-175mm



SPIRO - 1073

Table Top Basin
L-350, W-350, H-150mm



SPIRO STAND - 1073-S
L-487, W-320, H-115mm



SITRA - 1080
Table Top Basin
L-425, W-350, H-155mm



SIPRA - 1081
Table Top Basin
L-570, W-390, H-150mm



SAMRAT - 1082
Table Top Basin
L-575, W-375, H-140mm



STROY - 1084
Table Top Basin
L-510, W-250, H-130mm



SENCE- 1085
Table Top Basin
L-635, W-430, H-130mm



SINERIO - 1086
Table Top Basin
L-560, W-330, H-245mm



SANCITY- 1087
Table Top Basin
L-490, W-415, H-150mm



SPLASH - 1088

Table Top Basin
L-430, W-430, H-133mm



SYDNEY - 1089

Table Top Basin
L-380, W-380, H-120mm



SQUEEZE - 1090

Table Top Basin
L-556, W-355, H-120mm



SAPPY - 1091

Table Top Basin
L-535, W-385, H-120mm



SPRINT - 1092

Table Top Basin
L-420, W-420, H-130mm



SAILY - 1093

Table Top Basin
L-410, W-360, H-120mm



SMILE - 1094

Table Top Basin
L-435, W-332, H-120mm



SANDLY - 1095

Table Top Basin
L-450, W-400, H-120mm



SALER - 1096
Table Top Basin
L-560, W-408, H-160mm



SENORITA - 1097
Table Top Basin
L-430, W-430, H-135mm



SHUBH - 4051
Table Top Basin
L-355, W-355, H-120mm



SKA - 4054
Table Top Basin
L-400, W-300, H-115mm



SWEDE - 4055

Table Top Basin
L-450, W-350, H-120mm



MINI SPHERE - 4056

Table Top Basin
L-380, W-380, H-130mm



SHARK - 4059

Table Top Basin
L-470, W-360, H-120mm



SPARROW - 4060

Table Top Basin
L-565, W-385, H-120mm



CAPSULE - 4061

Table Top Basin
L-39, W-250, H-125mm



STARK - 4063

Table Top Basin
L-400, W-380, H-130mm



SCANIA - 4064

Table Top Basin
L-575, W-415, H-145mm



SPIN - 4065

Table Top Basin
L-430, W-310, H-110mm

MAG - 01



MAG - 02



MAG - 03



MAG - 04



MAG - 05

MAG - 06



MAG - 07-Y



MAG - 07-R



MAG - 07-B



MAG - 08

MAG - 09



MAG - 10



MAG - 11



MAG - 12



MAG - 13

MAG - 14



MAG - 15



MAG - 16



MAG - 17-B



MAG - 17-I

MAG - 18



MAG - 20



MAG - 21



MAG - 22



MAG - 23

MAG - 24



MAG - 25



MAG - 26



MAG - 28



MAG - 29



SEEKO - 2048

Wash Down One Piece Toilet

L-430, W-310, H-110mm

'S' Trap - 220/300mm - 'P' Trap - 180mm



SANTRO - 2041
Wash Down One Piece Toilet
L-685, W-375, H-635mm
'S' Trap - 100/300mm - 'P' Trap - 180mm



SONATA - 2042
Siphonic One Piece Toilet
L-660, W-355, H-720mm
'S' Trap - 100/220mm



SANCITY - 2043
Wash Down One Piece Toilet
L-630, W-350, H-735mm
'S' Trap - 220/300mm - 'P' Trap - 180mm



SENIGMA - 2044

Syphonic One Piece Toilet
L-660, W-355, H-720mm
'S' Trap - 220/300mm



SPRINT - 2045

Wash Down One Piece Toilet
L-650, W-360, H-720mm
'S' Trap - 220/300mm - 'P' Trap - 180mm



STYLO - 2046

Syphonic One Piece Toilet
L-690, W-410, H-830mm
'S' Trap - 300mm



STENO - 2047

Wash Down One Piece Toilet
L-650, W-345, H-740mm
'S' Trap - 220mm - 'P' Trap - 180mm



SPICE GOLD - 2026/2126

Couple Suite Toilet
L-685, W-390, H-800mm
P' Trap



SPICE GOLD - 2027/2126

Couple Suite Toilet
L-690, W-375, H-830mm
S' Trap



SPEED - 2035/2135

Couple Suite Toilet
L-710, W-460, H-810mm
P' Trap - 180mm



SPEED - 2035/2132

Couple Suite Toilet
L-710, W-460, H-810mm
'P' Trap - 180mm



STENZA - 2036/2136

Conselead Suite Toilet
L-730, W-355, H-830mm
'S' Trap - 180mm



SANCITY - 2038/2132

Couple Suite Toilet
L-710, W-460, H-810mm
'P' Trap - 180mm



SENSO - 2039/2139

Couple Suite Toilet
L-640, W-345, H-840mm
'S' Trap - 110mm



SPARROW - 2069

Wall Hung Toilet
L-520, W-345, H-365mm



STEPHY - 2050

Wall Hung Toilet
L-590, W-360, H-355mm



SPICE - 2051

Wall Hung Toilet
L-590, W-385, H-370mm



SAPLE - 2053

Wall Hung Toilet
L-495, W-360, H-380mm



SANDOZ - 2054

Wall Hung Toilet
L-625, W-445, H-365mm



SPARTAN - 2055

Wall Hung Toilet
L-505, W-380, H-395mm



SENIGMA - 2056

Wall Hung Toilet
L-545, W-355, H-350mm



SANTO - 2057

Wall Hung Toilet
L-495, W-345, H-370mm



SNOW - 2059

Wall Hung Toilet
L-515, W-345, H-345mm



SNEZZY - 2060

Wall Hung Toilet
L-597, W-365, H-345mm



SPRINT - 2062

Wall Hung Toilet
L-549, W-355, H-355mm



SPARX - 2064

Wall Hung Toilet
L-510, W-350, H-345mm



STENO - 2065

Wall Hung Toilet
L-540, W-355, H-400mm



STRAUSS - 2066
Wall Hung Toilet
L-550, W-345, H-350mm



STACY - 2067
Wall Hung Toilet
L-540, W-355, H-345mm



SUMO - 2068
Wall Hung Toilet
L-555, W-340, H-350mm



SAPHIRE - 2011
Concealed Water Closet
L-575, W-360, H-415mm
'S' Trap



SENIGMA - 2012
Concealed Water Closet
L-575, W-335, H-400mm
'P' & 'S' Trap



SHINTO - 2013
Concealed Water Closet
L-520, W-352, H-421mm
'P' Trap



SPARX - 2014
Concealed Water Closet
L-580, W-350, H-400mm
'S' & 'P' Trap



SPICE - 2023 'P' / 2024 'S'

Water Closet

2023 'P' - L-590, W-370, H-410mm

2024 'S' - L-570, W-360, H-410mm



SOLDIER - 2025

European Water Closet

L-490, W-360, H-410mm



SAMSON - 2073 'P' / 2074 'S'

Anglo Indian Water Closet

2073 'P' - L-605, W-450, H-400mm

2074 'S' - L-585, W-450, H-400mm



SHOWEY - 2061

Bidet

L-570, W-380, H-390mm



SCOOP - 1015

Counter Top Wash Basin
L-505, W-355, H-205mm



STYLE - 1040

Counter Top Wash Basin
L-565, W-415, H-220mm



STYLE - 1040

Under Counter Wash Basin
L-565, W-415, H-220mm



STEAM - 1050

Counter Top Wash Basin
L-445, W-380, H-190mm



SWAN - 1052

Counter Top Wash Basin
L-555, W-430, H-205mm



SWING - 1055

Under Counter Wash Basin
L-455, W-385, H-190mm



SIMPLE - 1071

Under Counter Wash Basin
L-450, W-320, H-160mm



SAVIT - 1072

Under Counter Wash Basin
L-500, W-375, H-205mm



SPLENDOUR - 1031

Cabinet Basin
L-900, W-545, H-220mm



SPLENDOUR - 1035

Cabinet Basin
L-770, W-480, H-225mm



SPLENDOUR - 1036

Cabinet Basin
L-910, W-480, H-225mm



SEEKO - 4066

One Piece Basin
L-350, W-360, H-270mm



SPARTAN - 1070

One Piece Basin
L-450, W-470, H-340mm



SHEEN - 1001

Wall Hung Basin
L-310, W-240, H-185mm



SOFT - 1002

Wall Hung Basin
L-455, W-245, H-160mm



SACHI - 1003

Wall Hung Basin
L-355, W-265, H-145mm



SINE - 1004

Wall Hung Basin
L-465, W-315, H-165mm



SATIN - 1005

Wall Hung Basin
L-365, W-365, H-210mm



STEPHEN Wall Hung Basin

1008-I L-450, W-300, H-190mm
1008 - L-465, W-330, H-200mm



STINGO-A - 1009-A

Wall Hung Basin
L-345, W-345, H-140mm



STINGO-B - 1009-B

Wall Hung Basin
L-400, W-400, H-128mm



SUSAN - 1010

Wall Hung Basin
L-380, W-335, H-220mm



SPARKLE - 1011

Wall Hung Basin
L-465, W-345, H-230mm



SUPER - 1012

Wall Hung Basin
L-465, W-365, H-180mm



STAR - 1017

Wall Hung Basin
L-510, W-305, H-155mm



SPOUSE - 1043

Wall Hung Basin
L-465, W-365, H-190mm



SHARP - 1047

Wall Hung Basin
L-445, W-330, H-195mm



SIGMA - 1048

Wall Hung Basin
L-375, W-295, H-190mm



SNOW - 1069

Wall Hung Basin
L-500, W-430, H-165mm



SARA - 4001

Wall Hung Basin
L-405, W-220, H-108mm



SONY - 4002

Wall Hung Basin
L-395, W-268, H-150mm



SURYA-A - 4004

Wall Hung Basin
L-450, W-350, H-150mm



SETU - 4005

Wall Hung Basin
L-445, W-360, H-135mm



SILK - 4009

Wall Hung Basin
L-460, W-260, H-180mm



SUMO - 4010

Wall Hung Basin
L-430, W-355, H-130mm



SIMBA - 4011

Wall Hung Basin
L-430, W-355, H-130mm



SQUARE - 4012

Wall Hung Basin
L-380, W-380, H-120mm



SPOT - 4013

Wall Hung Basin
L-410, W-315, H-180mm



SCARLET - 4014

Wall Hung Basin
L-455, W-370, H-130mm



SHEEP - 4015

Wall Hung Basin
L-460, W-250, H-125mm



SQUAD - 4016

Wall Hung Basin
L-370, W-260, H-130mm



SHIVAM - 4052

Wall Hung Basin
L-345, W-280, H-120mm



STRAUSS - 4053

Wall Hung Basin
L-385, W-460, H-150mm

TABLE TOP BASIN



SWEET - 6202
Table Top Basin
L-535, W-335, H-130mm



SECRET - 6204
Table Top Basin
L-590, W-450, H-148mm



SPA - 6203
Table Top Basin
L-545, W-280, H-170mm



STYLO - 6201
Table Top Basin/Wall Hung Basin
L-520, W-405, H-145mm



SECOND HALF - 6205
Table Top Basin
L-430, W-430, H-155mm



MAG - 30 - ORG



MAG - 30 - BLK



MAG - 29



SNEZZY - 1016/1117
Basin With Pedestal
L-610, W-490, H-870mm



SUP. GOLD MINI - 1024/1 124
Basin With Pedestal
L-510, W-440, H-840mm



SPICE GOLD - 1026/1 126
Basin With Pedestal
L-575, W-450, H-870mm



SOPHIA - 1027/1 127
Basin With Pedestal
L-570, W-425, H-850mm



SPEED - 1028/1 128
Basin With Pedestal
L-570, W-440, H-860mm



SUPRIME GOLD - 1029/1129

Basin With Pedestal
L-635, W-495, H-890mm



SWIDEN - 1030/1130

Basin With Pedestal
L-590, W-460, H-925mm



SPLENDOUR - 1031/1142

Basin With Pedestal
L-900, W-545, H-850mm



SPLENDOUR - 1032/1127

Basin With Pedestal
L-595, W-465, H-830mm



SERENA - 1033/1 133

Basin With Pedestal
L-590, W-470, H-960mm



STERLING - 1037/1 137

Basin With Pedestal
L-645, W-480, H-940mm



SENSO - 1038/1 138

Basin With Pedestal
L-555, W-430, H-900mm



SAMITE - 1041/1 145

Basin With Pedestal
L-530, W-435, H-900mm



STEPHY - 1045/1145

Basin With Pedestal
L-550, W-430, H-900mm



RAJWADI - 1061/1161

Basin With Pedestal
L-670, W-565, H-880mm



SIMON - 1064/1164

Basin With Pedestal
L-520, W-420, H-810mm



SONATA - 1065/1130

Basin With Pedestal
L-635, W-450, H-910mm



STENZA - 1067/1 167

Basin With Pedestal
L-560, W-440, H-870mm

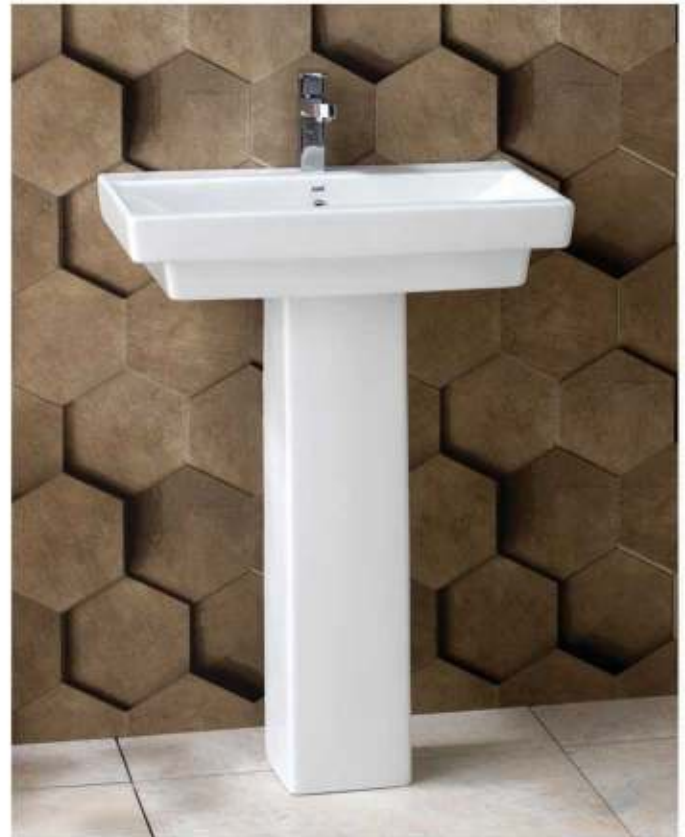

SIRI - 4006/1 1 17

Basin With Pedestal
L-590, W-410, H-810mm



SURYA-B - 4007/1 1 17

Basin With Pedestal
L-555, W-445, H-830mm



SANTOSA- 4008/1 1 18

Basin With Pedestal
L-610, W-490, H-870mm

BASIN WITH HALF PEDESTAL



SWISS - 1020/1 120

Basin With Half Pedestal
L-565, W-465, H-485mm



SALOME - 1022/1 122

Basin With Half Pedestal
L-510, W-440, H-530mm



**SNEZZY
1016/1 116**

Basin With Half Pedestal
L-550, W-445, H-575mm



SWIRL - 1066/1 166

Basin With Half Pedestal
L-530, W-430, H-440mm



SANTO - 1068/1 168

Basin With Half Pedestal
L-560, W-430, H-440mm

ONE PIECE TOILET



SIMANO - 6401
Syphonic One Piece Toilet
L-673, W-370, H-735mm
'S'Trap - 300mm



STYLO - 2046
Syphonic One Piece Toilet
L-685, W-410, H-830mm
'S'Trap - 300mm



SIMONA - 6103/7103
Basin With Pedestal
L-560, W-415, H-835mm



STYLO - 6101/7101
Basin With Pedestal
L-528, W-403, H-830mm



SICLAR - 6301 (RIMLESS)
European Water Closet
L-530, W-340, H-400mm
'S' & 'P' Trap



STYLO - 6104
One Piece Basin
L-500, W-400, H-425mm



SAVE - 6102
Wall Hung Basin
L-457, W-368, H-178mm



LARGE - 3000

Urinal
L-590, W-390, H-380mm

DIVIDER PLATE - 3013

L-710, W-355, H-130mm



CORNER - 3002

Urinal
L-435, W-270, H-350mm



SQUATING - 3003

Urinal
L-515, W-360, H-105mm



FLAT BACK - 3004

Urinal
L-445, W-355, H-265mm



STACY - 3005

Urinal
L-460, W-380, H-300mm



SESTO- 3006

Urinal
L-270, W-300, H-540mm



SQUARE - 2001/2002

Orissa Pan
2001 - L-560, W-430, H-300mm
2002 - L-595, W-450, H-310mm



SQUARE - 2004

Asian Pan
L-520, W-410, H-165mm



ACCU PAN - 2005

Orissa Pan
L-520, W-410, H-165mm



PVC CISTERN - 5001

SOAP TRAY
SPEED - 3108



PAPER HOLDER
SPEED - 3109



P TRAP BIG
3010



P TRAP
3011



COLOURS



Swan White



T. Blue



P. Green



Pink



Ivory



Grey

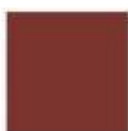

R. Brown

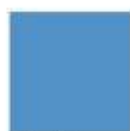

Alp. Blue



Majenta



So-blue



Aq-green

NOTE: Above printed colour may differ from colours of ceramic. For true selection refer to actual sample of shade board.

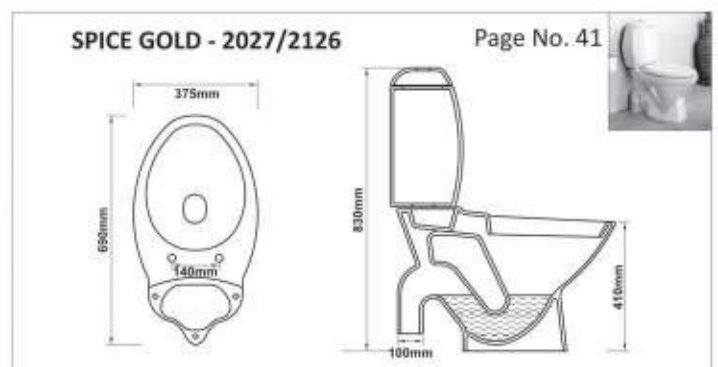
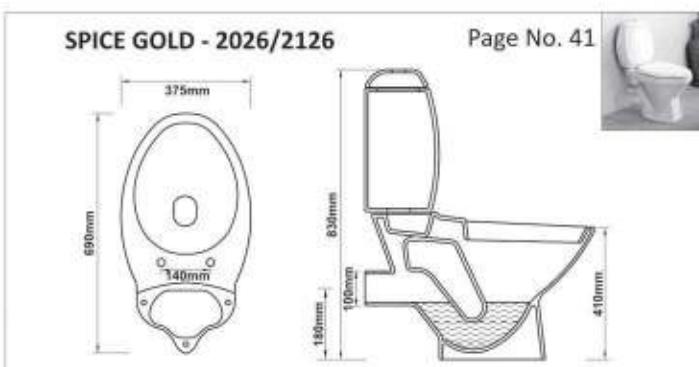
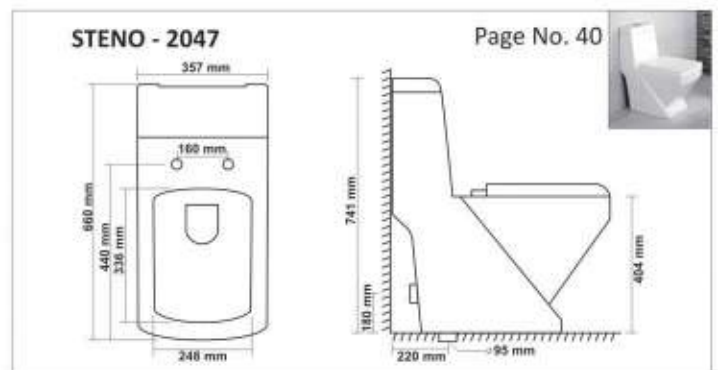
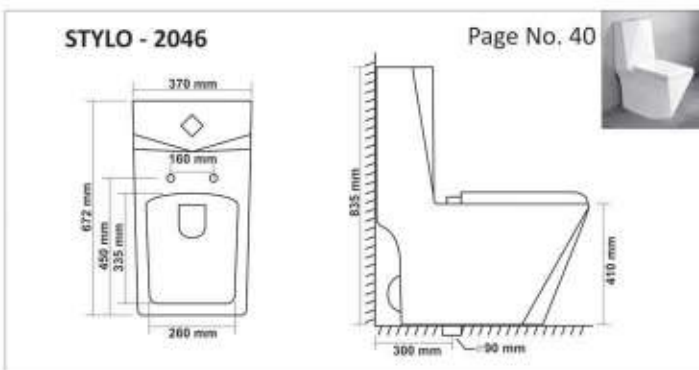
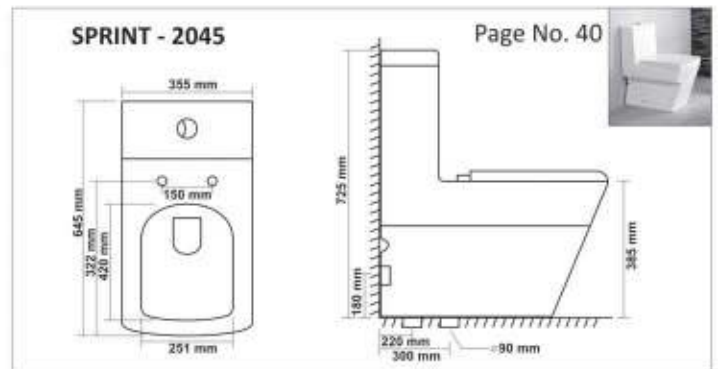
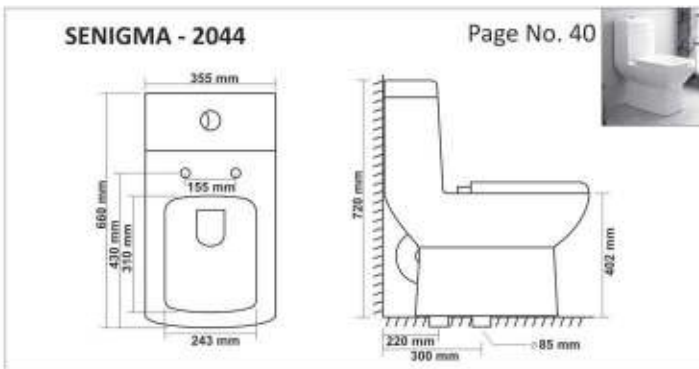
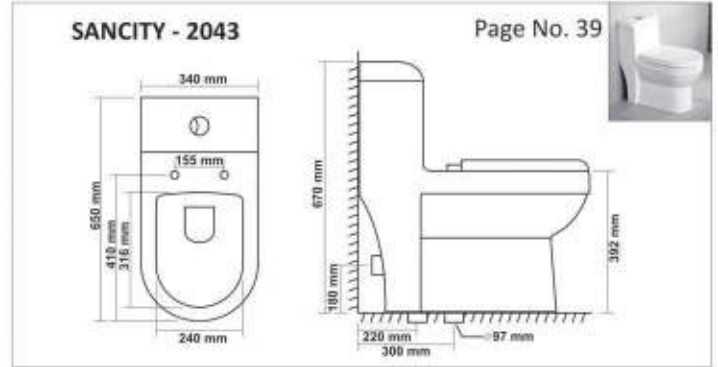
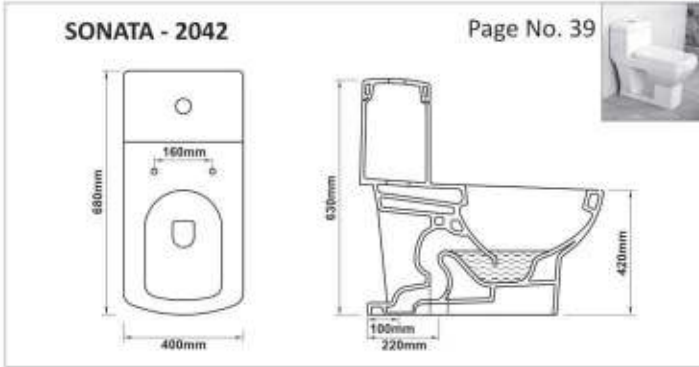
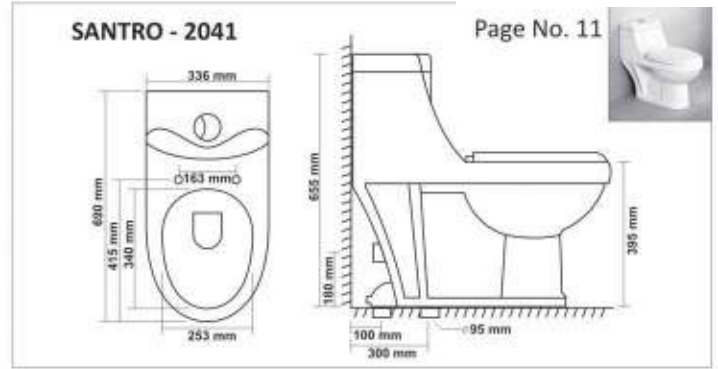
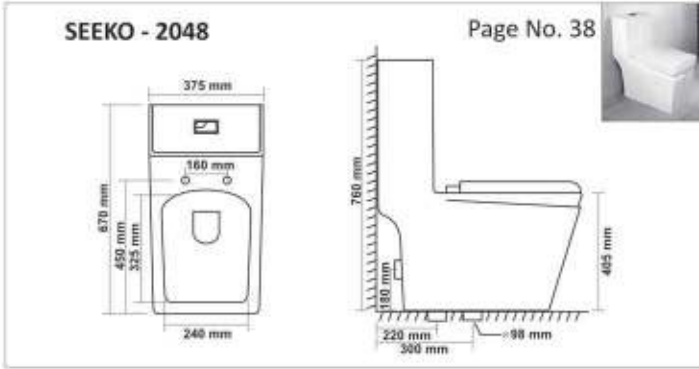

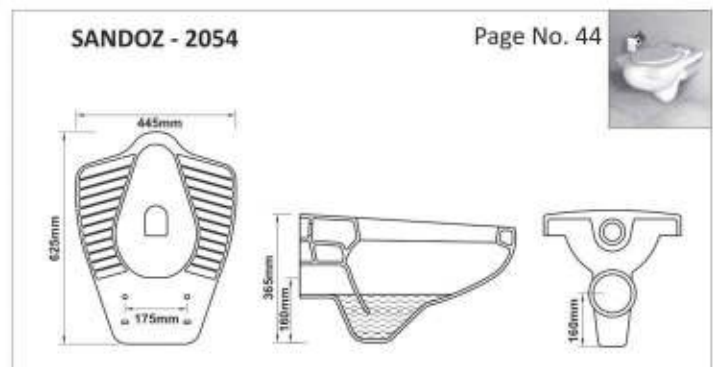
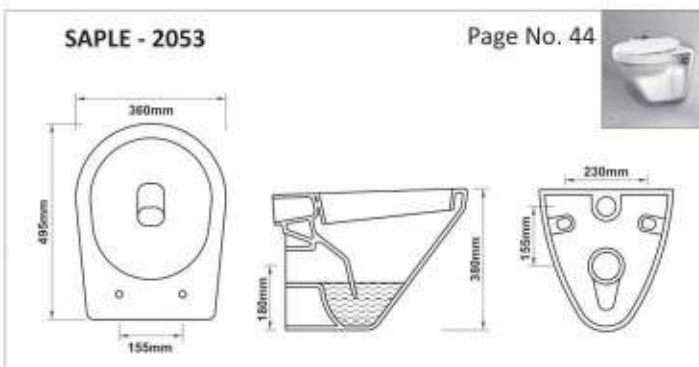
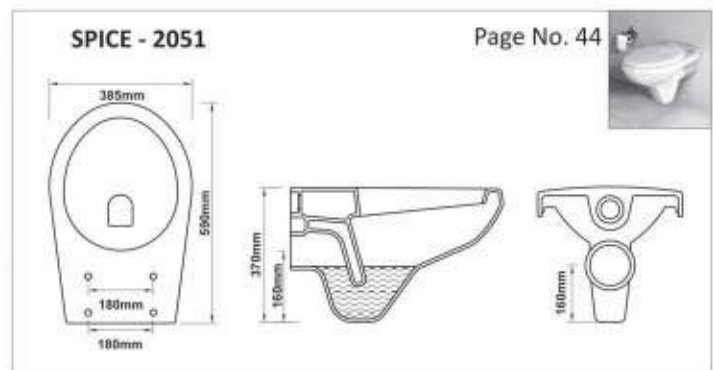
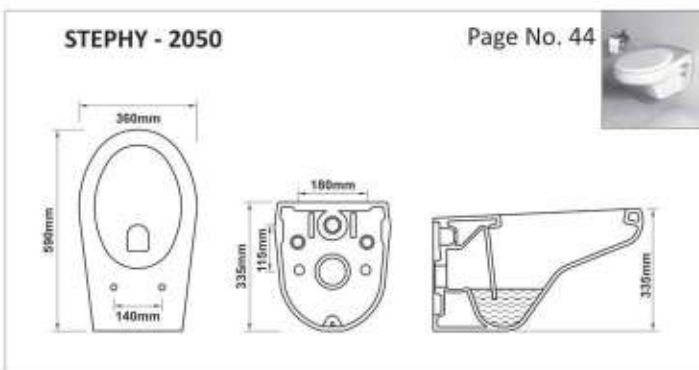
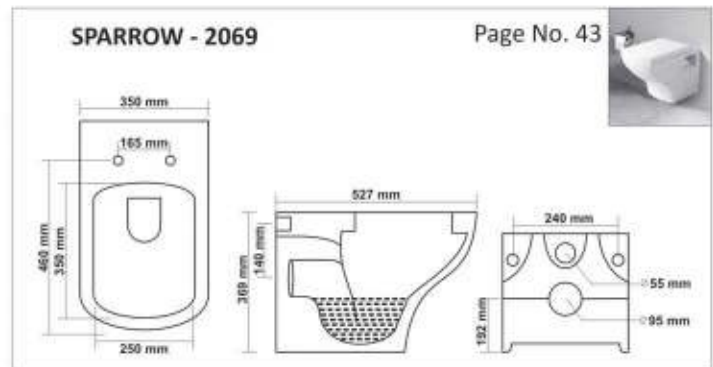
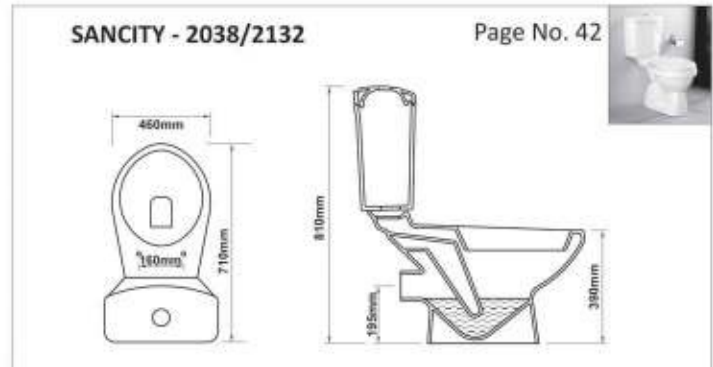
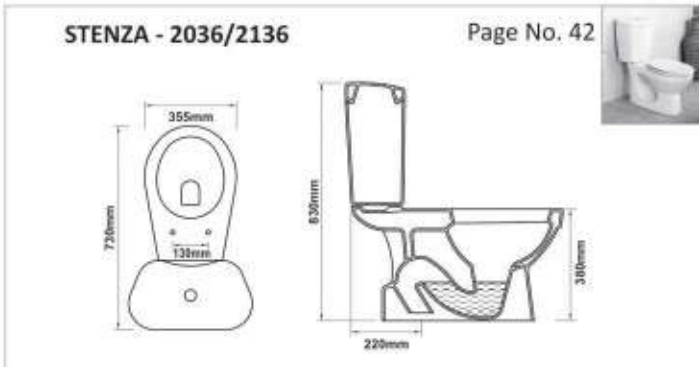
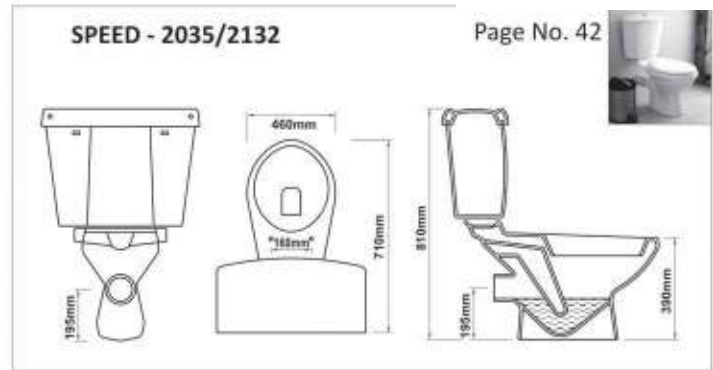
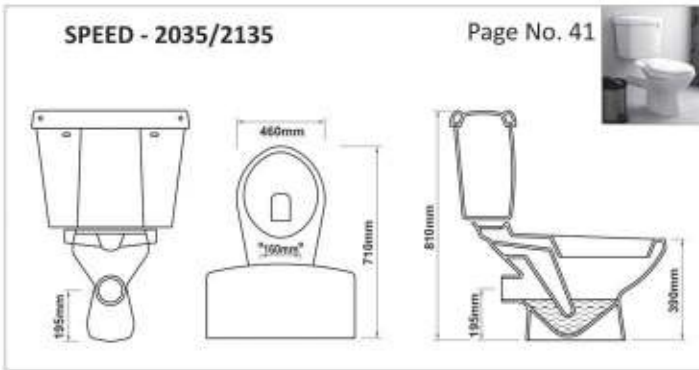

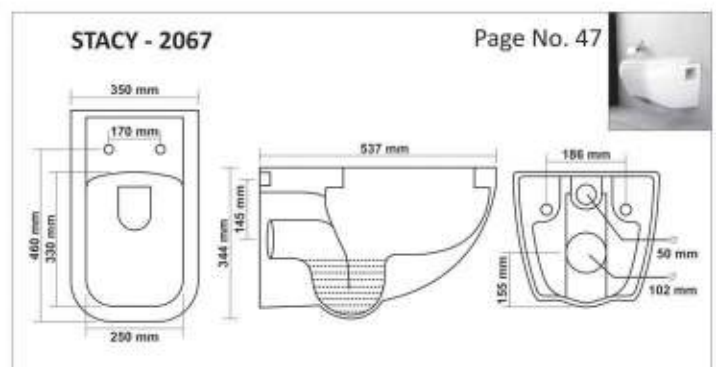
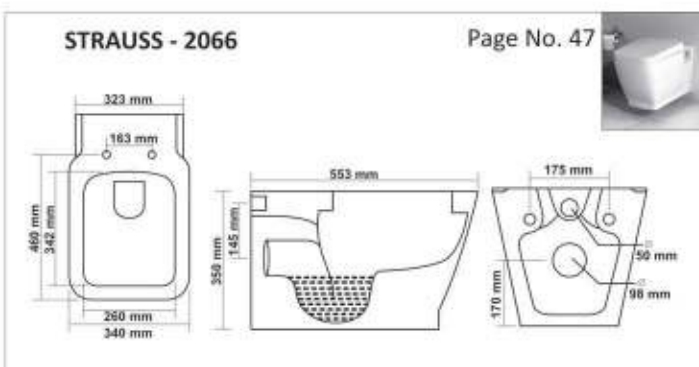
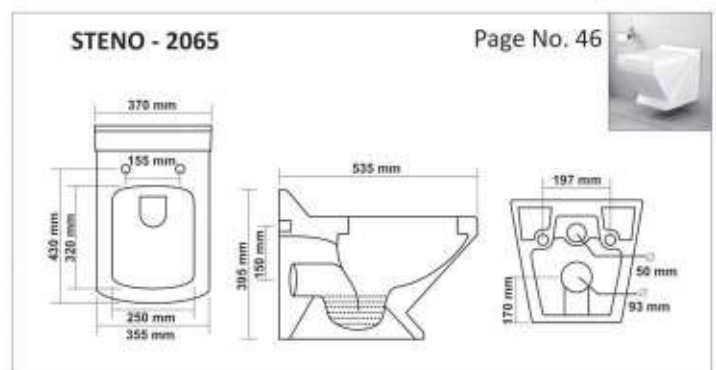
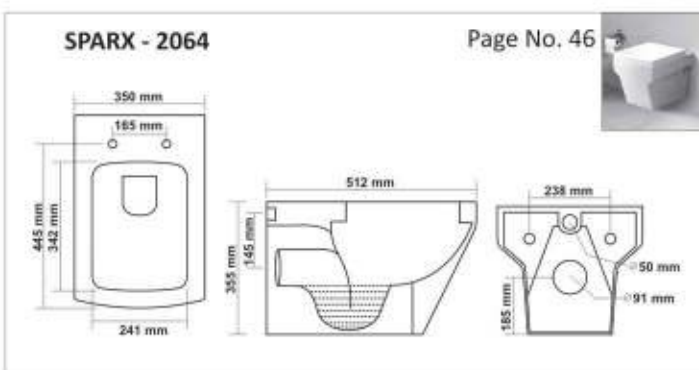
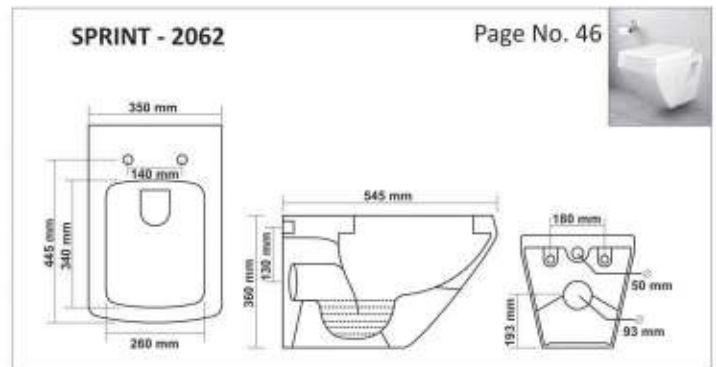
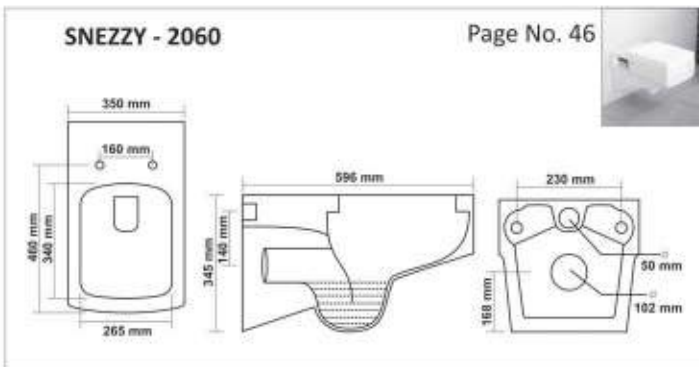
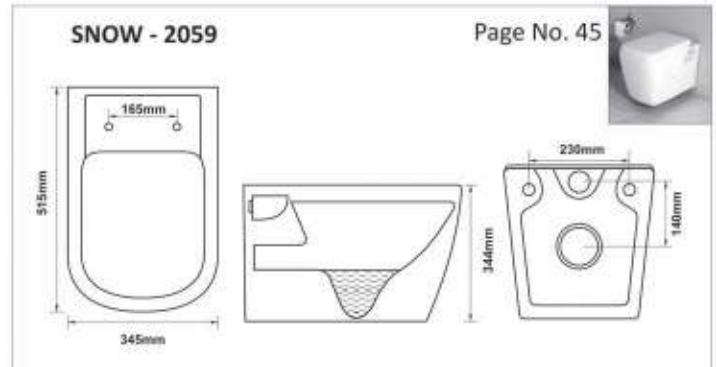
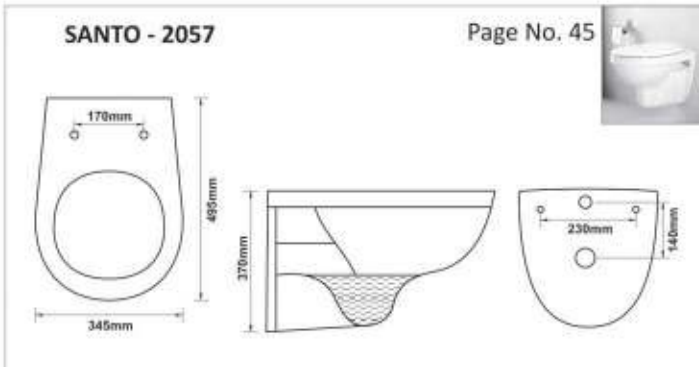
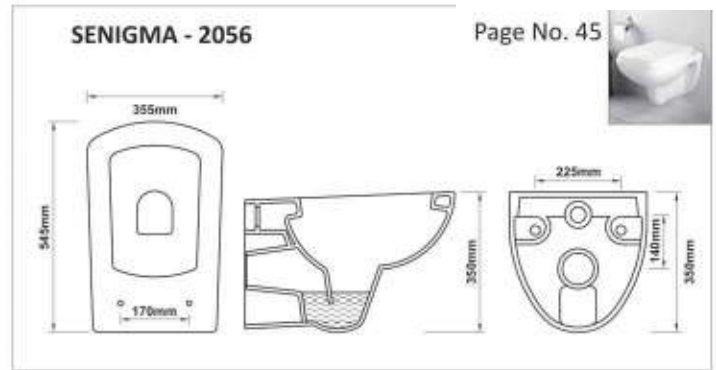
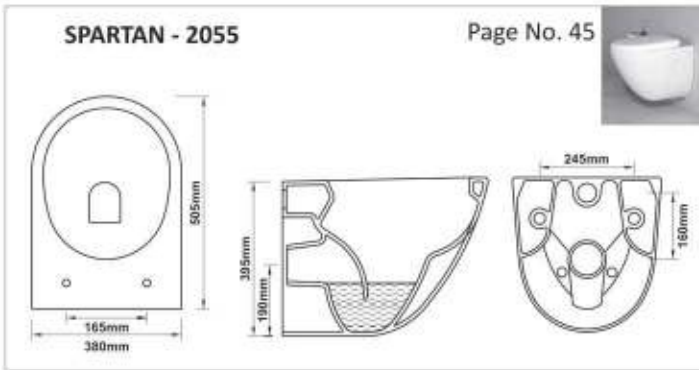

SUMO - 2068 Page No. 47

SAPHIRE - 2011 Page No. 48

SENIQMA EWC - 2012 Page No. 48

SHINTO - 2013 Page No. 48

SPARX EWC - 2014 Page No. 48

SPICE - 2023 'P'/2024 'S' Page No. 49

Trap	L	B	H	I	J	K	M
'P'	590	370	410	170	175	105	
'S'	570	360	410	170			105

SOLDIER - 2025 Page No. 49

SAMSON - 2073 'P'/2074 'S' Page No. 49

Trap	L	B	H	I	J	K	M
'P'	605	450	400	175	180		50
'S'	585	450	400	175		100	50

SHOWEY - 2061 Page No. 49

ITEM	PROBLEM	PROBABLE REASONS	CORRECTIVE ACTIONS
Wash Basins / Table Top	1. Overflow Choked And Foul Bed Odor	Waste Coupling Used May Be Full Threaded	Waste Coupling Should Be Changed To Slot Cut Coupling
	2. Water Deposit On Tap Platform Area And Inside Bowl Area	Basin Is Not Fixed In Level Or Bracket Is Not In Level	Should Be Done By Proper Leveling
	3. There Is No Tap Hole In Basin	Tap Hole Could Be Semi Punched From Back Side	Tap Hole Should Be Created By Plumber From Semipunched Area
Ewc / Pan / Anglo Indian	1. Water Not Coming In Bowl Area While Flushing	Flush Bend Is Not Inserted Up To The End Of Inlet Hole	Insert The Flush Pipe Up To The End Of Inlet (For Pan Closet: Check Whether Flush Pipe Is Not Covering Flush Hole Which Is In Both Side Of Inlet Wall
		Closet / Pan May Be Not Leveled	Should Be Done By Proper Leveling
One Piece Closet	1. Water Not Coming In Bowl Area While Flushing	Mechanism Inside Tank Could Not Working Properly	Change The Centre Pump Of Mechanism
		There Is No Water In Flush Tank	Increase The Ball Cock Height To The Max Level
	2. Water Is Continuously Leaking Inside The Bowl	Mechanism Inside Tank Could Not Working Properly	Change The Centre Pump Of Mechanism
	3. Water Quantity Insufficient For Effective Flushing	Ball Cock Height Adjusted At Lower Level	Increase The Ball Cock Height To The Max Level
Wallhung Water Closet	1. Water Not Coming In Bowl Area While Flushing	Flush Valve May Not Working Properly / Concealed Cistern Is Not Working Properly	Should Change Flush Valve / Concealed Cistern
		Flush Pipe Is Not Inserted Up To The End Of Inlet Hole	Insert The Flush Pipe Up To The End Of Inlet
	2. Water Is Continuously Leaking Inside The Bowl	Closet Is Not Leveled Properly	Closet Should Be In Proper Level
	3. Water Quantity Insufficient For Effective Flushing	Connection Between Closet Outlet And Drainage Pipe Is Not Proper	Should Be Done By Proper Connection By Experienced Plumber
Couple Closet (2 Pcs Closet)	1. Uneven Flow Of Water From Both Side Of Closet Bowl	Both Arm Of Diverter Pipe Not Inserted Equally In Both Side Of The Closet	Both Arm Of Diverter Pipe Should Be Inserted Equally In Both Side Of The Closet
	2. Water Is Leaking Between The Cistern And Closet	Diverter Pipe Not Fixed Properly In The Outlet Of Cistern	Diverter Pipe Should Be Fixed Properly In The Outlet Of Cistern
		Rubber Ring Containing Bolt Is Not Tightened Properly	Rubber Ring Containing Bolt Should Be Tightened Properly

TECHNICAL SPECIFICATION

Technical Specification of vitreous sanitary ware as per IS 2556 (Part) : 1994

NAME OF TEST	AS PER IS 2556 (Part) 1994	TEST VALUES
1. Water Absorption	Average value should not exceed more than 0.5%	Max 0.30% show better vitrification
2. Crazeing Test	No crazeing up to 2 cycle up 5 hrs each cycle or 10 hours at pressure 0.34 to 0.37 Mps.	No problem up to 4 cycle and no crazeing
3. Chemical Resistance	No loss of reflectivity of the glaze when compared with control sample.	No loss of reflectivity of the glaze when compared with control sample
4. Modules of Repture	Not less than 60 Mpa.	Min. 65 Mpa. / Min. 80 Mpa.
5. Resistance to Staining and Burning	No stain shall remain on either of test piece	No stain shall remain on either of test piece
6. Discoloration	None on all visible surface	None on all visible surface
7. Wavy Finish	None on all visible surface	None on all visible surface

Note : All products dimension may vary 10% to 15% from the dimension given in the catalogue.

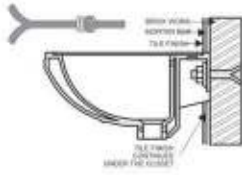

WALL HUNG BASIN

As per shown in the picture, the rag bolt must be grouted into the cement/concrete wall. The bolts must be fixed to the cement/concrete wall. Allow setting & checking than install it using nut and washer.

COUNTER WASHBASIN

At the beginning

1. A skilled or experienced person should install counter lavatories.
2. Avoid using adhesive with this product.
3. Check the waste area and supply tubing if required.
4. Do not open the lavatory from its protective carton until you are ready for installation.
5. Please follow all local building and plumbing codes.

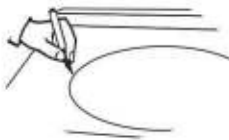

MATERIAL & TOOLS

Measure tape, Keyhole or saber saw, Hammer, Glasses, Rags or Paper toweling, Drill (1/2 dia, drill bit or larger), Pencil, sealant, sharp knife or scissors.

INSTALLATION OF LAVATORY

Please Note : Please install it in a way that future removal from underneath the counter top is possible without damaging the counter top.

1. Please check the desired location for clearance between the back splash, faucet, Fixture and cabinet.
2. Please cut the template.
3. Please carefully trace the template on the counter top directed.
4. Please mark the faucet hole centerline on the counter top.
5. Please drill a 1/2" pilot on the inside of the cut line.



For Wood Counter tops:

1. Mark and pre-drill the wood screw holes at the locations shown on the template.
2. Waterproof any exposed areas of wood.

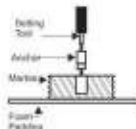

For Marble Counter tops:

1. Position the counter top upside down on foam padding to protect the surface. Mark and drill 3/6" holes 5/8" deep at the locations shown on the template.
2. Use a setting tool and hammer to secure the anchors.



For All Installations:

1. If the counter top has not been installed, install it at this time.
2. Drill the faucet holes according to the faucet installation instructions.
3. Install the faucet to the counter top according to the manufacture's instructions.
4. Install the drain to the lavatory according to the manufacture's instructions.

MAINTENANCE

Like any other part of your house, the bathroom can be made to look great and made to last long if it is taken care of regularly. To make your bathroom beautiful here are some invaluable tips.

Wash Basin :

A mild detergent can be used to wash the basin at least once a day. After washing, the basin should be wiped out clearly to avoid water stains.

Closets :

Cleanser like Harpic can be used to clear the closet with soft plastic brush, at least once a day.

To avoid minute discoloring, after flushing the toilet give it a once over with the soft brush.

Keep the toilet brush handy in a convenient stand nearby.

In case of toilets and basins, if there has been no maintenance since long period of time, water deposits and discoloration can form on the surface of areas that get wet. In such cases, these stains/marks can be removed with the help of a solution of dilute hydrochloric acid.

Clean with a soft cotton cloth and warm water with soap.

Do not use thinner, day cleaning liquids or powder paste. Use a liquid cleaner at least twice a week.

Use brasso or car rubbing compound and then polish with a cloth to remove fine scratches.



73 A/1 of 144 - 145 J N Mukherjee Road,
Ghusuri, Howrah - 711107



+91 9830788019
+91 9903009916



<http://www.beceramica.com>